

DENON



Owner's Manual

DSD-501

SAFETY PRECAUTIONS



CAUTION
RISK OF ELECTRIC SHOCK
DO NOT OPEN



CAUTION:
TO REDUCE THE RISK OF ELECTRIC SHOCK, DO NOT REMOVE COVER (OR BACK). NO USER-SERVICEABLE PARTS INSIDE. REFER SERVICING TO QUALIFIED SERVICE PERSONNEL.

The lightning flash with arrowhead symbol, within an equilateral triangle, is intended to alert the user to the presence of uninsulated "dangerous voltage" within the product's enclosure that may be of sufficient magnitude to constitute a risk of electric shock to persons.

The exclamation point within an equilateral triangle is intended to alert the user to the presence of important operating and maintenance (servicing) instructions in the literature accompanying the appliance.

WARNING:
TO REDUCE THE RISK OF FIRE OR ELECTRIC SHOCK, DO NOT EXPOSE THIS APPLIANCE TO RAIN OR MOISTURE.

IMPORTANT SAFETY INSTRUCTIONS

1. Read these instructions.
2. Keep these instructions.
3. Heed all warnings.
4. Follow all instructions.
5. Do not use this apparatus near water.
6. Clean only with dry cloth.
7. Do not block any ventilation openings. Install in accordance with the manufacturer's instructions.
8. Do not install near any heat sources such as radiators, heat registers, stoves, or other apparatus (including amplifiers) that produce heat.
9. Protect the power cord from being walked on or pinched particularly at plugs, convenience receptacles, and the point where they exit from the apparatus.
10. Only use attachments/accessories specified by the manufacturer.
11. Use only with the cart, stand, tripod, bracket, or table specified by the manufacturer, or sold with the apparatus. When a cart is used, use caution when moving the cart/apparatus combination to avoid injury from tip-over.
12. Unplug this apparatus during lightning storms or when unused for long periods of time.
13. Refer all servicing to qualified service personnel. Servicing is required when the apparatus has been damaged in any way, such as power-supply cord or plug is damaged, liquid has been spilled or objects have fallen into the apparatus, the apparatus has been exposed to rain or moisture, does not operate normally, or has been dropped.
14. Batteries shall not be exposed to excessive heat such as sunshine, fire or the like.



CAUTION:

To completely disconnect this product from the mains, disconnect the plug from the wall socket outlet. The mains plug is used to completely interrupt the power supply to the unit and must be within easy access by the user.

DECLARATION OF CONFORMITY

Our products following the provisions of EC/EU directives, that as follows:
LV: 2006/95/EC
EMC: 2004/108/EC
RoHS: 2011/65/EU
ErP: EC regulation 1275/2008 and its frame work directive 2009/125/EC
R&TTE: 1999/5/EC

Denon Europe
Division of D&M Germany GmbH
An der Kleinbahn 18, Nettetal,
D-41334 Germany

A NOTE ABOUT RECYCLING:

This product's packaging materials are recyclable and can be reused. Please dispose of any materials in accordance with the local recycling regulations.

When discarding the unit, comply with local rules or regulations.

Batteries should never be thrown away or incinerated but disposed of in accordance with the local regulations concerning battery disposal.

This product and the supplied accessories, excluding the batteries, constitute the applicable product according to the WEEE directive.



Pb

☐ NOTES ON USE

WARNINGS

- Avoid high temperatures.
Allow for sufficient heat dispersion when installed in a rack.
- Handle the power cord carefully.
Hold the plug when unplugging the cord.
- Keep the unit free from moisture, water, and dust.
- Unplug the power cord when not using the unit for long periods of time.
- Do not obstruct the ventilation holes.
- Do not let foreign objects into the unit.
- Do not let insecticides, benzene, and thinner come in contact with the unit.
- Never disassemble or modify the unit in any way.
- Ventilation should not be impeded by covering the ventilation openings with items, such as newspapers, tablecloths or curtains.
- Naked flame sources such as lighted candles should not be placed on the unit.
- Observe and follow local regulations regarding battery disposal.
- Do not expose the unit to dripping or splashing fluids.
- Do not place objects filled with liquids, such as vases, on the unit.
- Do not handle the mains cord with wet hands.
- When the switch is in the OFF (STANDBY) position, the equipment is not completely switched off from MAINS.
- The equipment shall be installed near the power supply so that the power supply is easily accessible.
- Do not keep the battery in a place exposed to direct sunlight or in places with extremely high temperatures, such as near a heater.

1. IMPORTANT NOTICE: DO NOT MODIFY THIS PRODUCT

This product, when installed as indicated in the instructions contained in this manual, meets R&TTE directive requirements. Modification of the product could result in hazardous Radio and EMC radiation.

2. CAUTION

- Separation distance of at least 20 cm must be maintained between this product and all persons.
- This product and its antenna must not be co-located or operating in conjunction with any other antenna or transmitter.

☐ CAUTIONS ON INSTALLATION

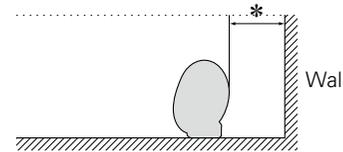
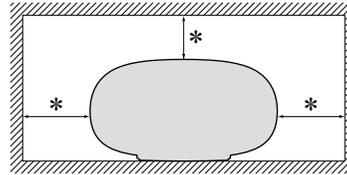

* For proper heat dispersal, do not install this unit in a confined space, such as a bookcase or similar enclosure.

- More than 0.3 m is recommended.

Getting started

Thank you for purchasing this Denon product. To ensure proper operation, please read this owner's manual carefully before using the product. After reading this manual, be sure to keep it for future reference.

Contents

Getting started	1
Accessories	1
Features	2
Cautions on handling	2
Remote operation	3

Preparation

4

Connections	5
Connecting the power cord	5
Connecting a portable player	5
Connecting an iPhone or iPod	6
Connecting to a home network (LAN)	7
Required system	7
Network connections	8

Operation

10

Playback	11
Preparation	11
Operations possible during playback	11
Playing an iPhone and iPod with the USB cable connected	12
AirPlay function	13
Listening to Internet Radio	15
Playing a portable player	15
Playing back files stored on a PC or NAS (Network Attached Storage) with the Cocoon App (Music Server)	16
How to make detailed settings	19
Menu map	19
Setting up the network (Network Info.)	20
Firmware Update	20
Setting the volume limit (Max Volume Level)	21
Setting the language (Language)	21
Setting the clock (Clock)	22
Auto-Standby	24
Network Control	24
Wi-Fi Protected Setup (WPS) Settings (PIN code method)	24

Information

25

Part names and functions	26
Front panel	26
Rear panel	26
Remote control unit	27
Other information	28
Trademark information	28
Explanation of terms	29
Troubleshooting	31
Resetting the microprocessor (Factory Reset)	33
Specifications	33

Accessories

Check that the following parts are supplied with the product.

① Quick Setup Guide	1
② Safety Instructions	1
③ Notes on radio	1
④ Power cord	1
⑤ Remote control unit	1
⑥ R03/AAA batteries	2

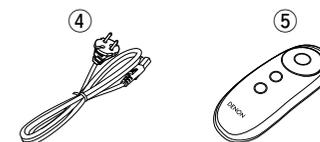

Features

Compatible with the AirPlay® function

(👉 [page 13](#))

You can enjoy easy streaming playback of music from your iPhone and iPod touch. During playback, the song titles and artist names appear on the display.

Compatible with “Cocoon App” for performing basic operations of the unit with an iPhone®, iPod touch® and iPad® (👉 [page 3](#))

Compatible with Internet Radio (👉 [page 15](#)) Also equipped with the Music Server function that plays back audio content on the network (👉 [page 16](#))

In addition to music files stored on a PC and music servers on the network, you can enjoy various audio sources on the Internet such as Internet Radio.

Equipped with an organic EL (electro-luminescent) display with great visibility

With an EL display high contrast and low power consumption can be achieved. Song titles and artist names are clearly displayed.

Cautions on handling

• Before turning the power on

Check once again that all connections are correct and that there are no problems with the connection cables.

- Power is supplied to some of the circuitry even when the unit is set to the standby mode. When going on vacation or leaving home for long periods of time, be sure to unplug the power cord from the power outlet.

• About condensation

If there is a major difference in temperature between the inside of the unit and the surroundings, condensation (dew) may form on the operating parts inside the unit, causing the unit not to operate properly.

If this happens, let the unit sit for an hour or two with the power turned off and wait until there is little difference in temperature before using the unit.

• Cautions on using mobile phones

Using a mobile phone near this unit may result in noise. If that occurs, move the mobile phone away from this unit when it is in use.

• Moving the unit

Turn off the power and unplug the power cord from the power outlet. Next, disconnect the connection cables to other system units before moving the unit.

• About care

- Wipe the cabinet and control panel clean with a soft cloth.
- Follow the instructions when using a chemical cleaner.
- Benzene, paint thinner or other organic solvents as well as insecticide may cause material changes and discoloration if brought into contact with the unit, and should therefore not be used.

Remote operation

About the remote control unit

Inserting the batteries

- 1 Remove the rear lid in the direction of the arrow and remove it.
- 2 Load the two batteries properly as indicated by the marks in the battery compartment.

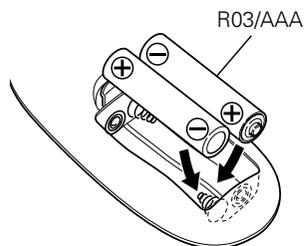
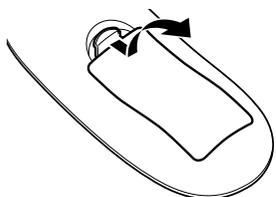

- 3 Put the rear cover back on.

NOTE

- Insert the specified batteries in the remote control unit.
- Replace the batteries with new ones if the set does not operate even when the remote control unit is operated close to the unit. (The supplied batteries are only for verifying operation. Replace them with new batteries at an early date.)
- When inserting the batteries, be sure to do so in the proper direction, following the ⊕ and ⊖ marks in the battery compartment.
- To prevent damage or leakage of battery fluid:
 - Do not use a new battery together with an old one.
 - Do not use two different types of batteries.
 - Do not attempt to charge dry batteries.
 - Do not short-circuit, disassemble, heat or dispose of batteries in flames.
 - Do not keep the battery in a place exposed to direct sunlight or in places with extremely high temperatures, such as near a heater.
- If the battery fluid should leak, carefully wipe the fluid off the inside of the battery compartment and insert new batteries.
- Remove the batteries from the remote control unit if it will not be in use for long periods.
- Used batteries should be disposed of in accordance with the local regulations regarding battery disposal.
- The remote control unit may function improperly if rechargeable batteries are used.

Operating range of the remote control unit

Point the remote control unit at the remote sensor when operating it.

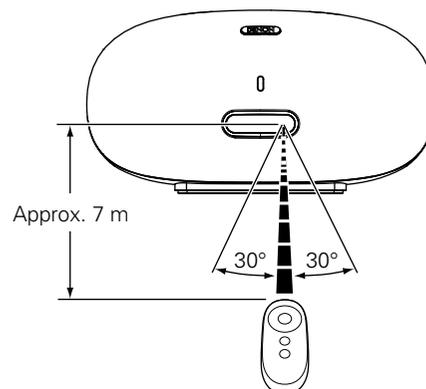

NOTE

- The set may function improperly or the remote control unit may not operate if the remote control sensor is exposed to direct sunlight, strong artificial light from an inverter type fluorescent lamp or infrared light.
- When using 3D video devices that transmit radio communication signals (such as infrared signals etc) between the various units (such as the monitor, 3D glasses, 3D transmitter unit etc), the remote control unit may not operate due to interference from those radio communication signals. If this occurs, adjust the direction and distance of the 3D communication for each unit, and check that the remote control unit operation is not affected by these signals.

Cocoon App



Cocoon App is Denon's proprietary application developed for iPhone, iPod touch, iPad and Android smartphone.

After you install Cocoon App on your iPhone, iPod touch, iPad, or Android smartphone, you can use Cocoon App to perform the following operations.

- Operate this unit
- Manually make the wireless LAN settings on this unit ([page 8](#))
- Change preset Internet Radio stations ([page 15](#))

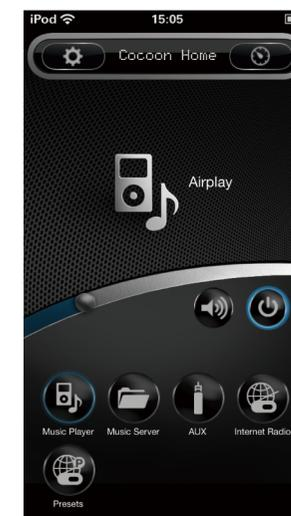

- Bidirectional communication is performed.
- The Cocoon App can be downloaded for free from the App Store or Google Play.
- Use the latest Cocoon App.
- Screens are subject to change without notice.

Preparation

Here, we explain the connections methods for this unit.

● Connections [page 5](#)



 [page 5](#)



 [page 5](#)



 [page 6](#)

● Connecting to a home network (LAN) [page 7](#)



 [page 8](#)



 [page 8](#)

For the part names of the main unit and remote control unit, see "Part names and functions" ( [page 26](#)).

Connections

NOTE

- When making connections, also refer to the owner's manual of the other components.
- Do not bundle power supply cords together with connection cables. Doing so can result in hum or noise.

Connecting the power cord

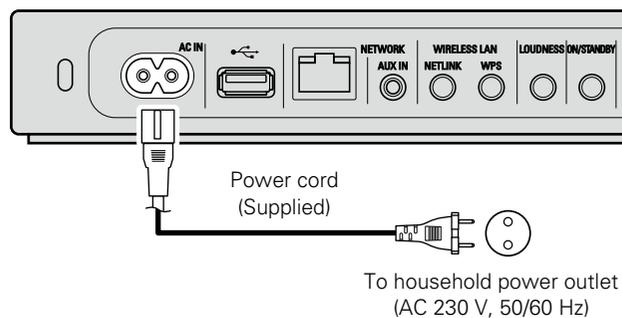

NOTE

- Only use the supplied power cord.
- Be sure the power cord is unplugged from the power outlet before connecting or disconnecting it to the AC inlet.

Connecting a portable player

- If a portable player is connected via the AUX IN jack of the unit, music from the portable player can be played.
- For operating instructions see "Playing a portable player" ([page 15](#)).

Cables used for connections

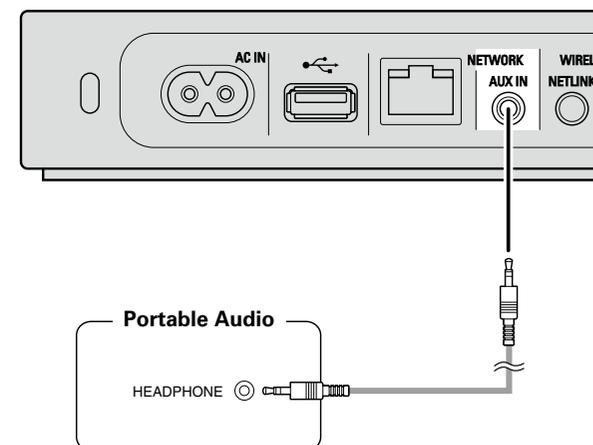
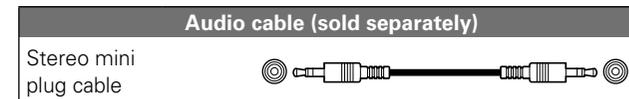

Connecting an iPhone or iPod

- You can enjoy music stored on an iPhone or iPod.
- Use the USB cable that comes with the iPhone or iPod to connect the device.
- For operating instructions see “Playing an iPhone and iPod with the USB cable connected” ([page 12](#)).

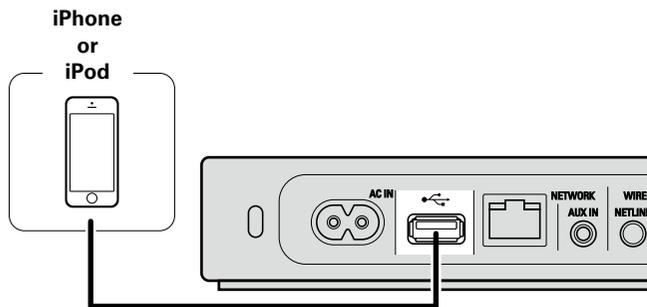

- When the input source of this unit is “iPod”, the iPhone and iPod connected will be charged.

NOTE

- The iPhone or iPod cannot be charged during AirPlay.
- This unit does not support playback of USB memory device.
- Depending on the type of iPhone or iPod and the software version, some functions may not operate.
- Note that Denon will accept no responsibility whatsoever for any problems arising with the data on an iPhone or iPod when using this unit in conjunction with the iPhone or iPod.

Supported iPod / iPhone models

• iPod / iPod classic



iPod classic
80GB



iPod classic
160GB (2007)



iPod classic
160GB (2009)

• iPod nano



iPod nano
2nd generation
(aluminum)
2GB 4GB 8GB



iPod nano
3rd generation
(video)
4GB 8GB



iPod nano
4th generation (video)
8GB 16GB



iPod nano
5th generation (video camera)
8GB 16GB



iPod nano
6th generation
8GB 16GB



iPod nano
7th generation
16GB

• iPod touch



iPod touch
2nd generation
8GB 16GB 32GB



iPod touch
3rd generation
32GB 64GB



iPod touch
4th generation
8GB 32GB 64GB



iPod touch
5th generation
32GB 64GB

• iPhone



iPhone
4GB 8GB 16GB



iPhone 3G
8GB 16GB



iPhone 3GS
8GB 16GB 32GB



iPhone 4
16GB 32GB



iPhone 4S
16GB 32GB 64GB



iPhone 5
6GB 32GB 64GB

Connecting to a home network (LAN)

When this unit is connected to your home network (LAN), you can enjoy various audio sources via the network.

- Streaming playback from your iPhone or iPod touch with AirPlay
- Internet Radio
- Music files on music servers

Furthermore, you can operate this unit by using the Cocoon App on your iPhone, iPod touch, iPad and Android smartphone.

Required system

Broadband internet connection

Modem

Device that connects to the broadband circuit and conducts communications on the Internet.

A type that is integrated with a router is also available.

Router

When using this unit, we recommend you use a router equipped with the following functions:

- Built-in DHCP server

This function automatically assigns IP addresses on the LAN.

- Built-in 100BASE-TX switch

When connecting multiple devices, we recommend a switching hub with a speed of 100 Mbps or greater.

- When using with a wireless LAN, prepare a broadband router with built-in access point.

LAN cable (supplied)

(CAT-5 or greater recommended)

- Use only a shielded STP or ScTP LAN cable which is available at your electronics retailer.
- The normal shielded-type LAN cable is recommended. If a flat-type cable or unshielded-type cable is used, other devices could be affected by noise.

NOTE

- A contract with an ISP is required to connect to the Internet. No additional contract is needed if you already have a broadband connection to the Internet.
- The types of routers that can be used depend on the ISP. Contact an ISP or a computer shop for details.
- Denon assumes no responsibility whatsoever for any communication errors or troubles resulting from customer's network environment or connected devices.
- This unit is not compatible with PPPoE. A PPPoE-compatible router is required if you have a contract for a type of line set by PPPoE.
- To listen to audio streaming, use a router that supports audio streaming.

Network connections

There are two types of network connections available – wired and wireless. Select either of them according to your router functions and operating environment.

Make network connections by referring to the provided “Quick Setup Guide”.

This manual only explains how to enter detailed information such as the proxy server and IP address for network connection (page 9).

Wireless LAN

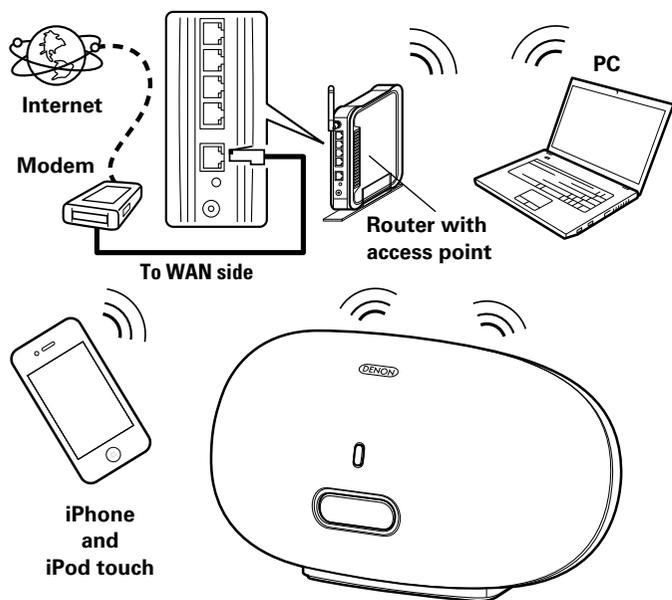

Wired LAN

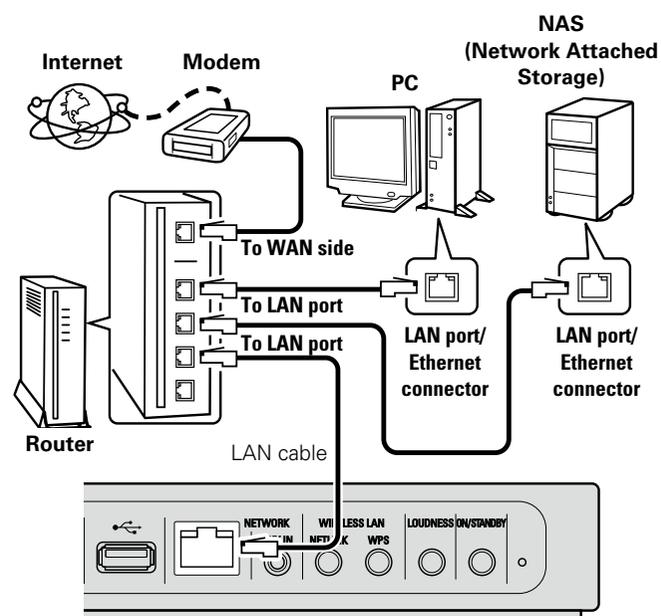

NOTE

Do not connect the NETWORK connector directly to the LAN port/Ethernet connector on your computer.

Using PC to make network settings of this unit



Before turning this unit on, make sure that no Ethernet cable is connected to this unit. If a cable is connected, unplug this unit's power cord, then disconnect the cable.

1 Press to turn on power to the main unit.

It takes approximately 30 seconds for this unit to start.

2 Press **NETLINK** on the rear panel for 3 seconds.

This unit restarts and "Reboot in NetLink mode" appears on the display.

3 Connect to "Cocoon_Setup *****" in the wireless network settings on your PC. (***** is the MAC address)

- If "Cocoon_Setup *****" is not displayed, refresh the network.
- It may take up to two minutes to establish the connection.

4 Launch the browser on the PC connected to this unit, and enter the address "<http://169.254.1.1>".

5 On the page that appears, set the information necessary for the network connection.

- ① Click "Profile Configuration" on the upper left part of the page.
- ② Select the SSID to be used.
- ③ Click "ADVANCE SETTING".
- ④ Enter required items.
- ⑤ When settings are completed, click "Apply".

- "Connecting" is displayed, and the unit starts connecting to the LAN.
- When the connection is made successfully, "Connected!" appears.
- If the connection cannot be established, "Connection Failed" is displayed. If this should happen, unplug this unit's power cord, then plug it back in and repeat the operation from step 1 to step 5.

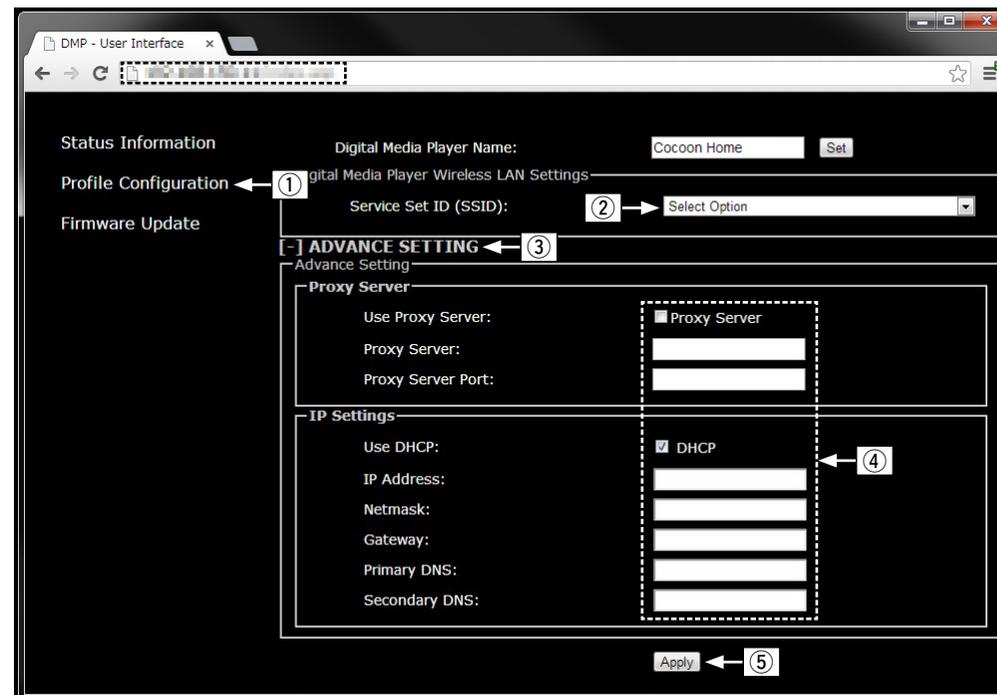

Operation

Here, we explain functions and operations that let you make better use of this unit.

● Playback [page 11](#)

 iPod  page 12
 PORTABLE PLAYER  page 15

 AirPlay  page 13
 PC/NAS/DMS  page 16

 Internet Radio  page 15
--

● How to make detailed settings [page 19](#)

Playback

This section provides how to play back music with this unit.
This unit can play back music from the following devices (media).

- iPhone and iPod
 - When connected to this unit ([page 12](#))
 - When using AirPlay ([page 13](#))
- Internet Radio ([page 15](#))
- Portable player ([page 15](#))
- Music server (PC on the network) ([page 16](#))

Preparation

Turning the power on

Press  to turn on power to the unit.

This unit is turned on and the operation button on top lights.

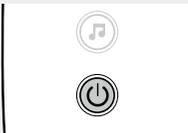

- When the latest firmware is available, “” ([page 20](#)) “Firmware Update”) and “Update Available” are displayed. Use + or – to select “Update Now”, then press .



You can also switch the power to standby by pressing **ON/STANDBY** on the main unit.

Set the network function on/off during standby

For settings, see “Network Control” ([page 24](#)).

When power is switched to standby

Press .

- The display is turned off and this unit enters the standby mode.
- When “Network Control” ([page 24](#)) is set to “Network Always On”, the indicators for operation buttons on the top of this unit remain lit.

In this situation, you can turn on the power from Cocoon App.

Completely turning off the power

Power continues to be supplied to some of the circuitry even when the unit is in the standby mode. When leaving home for long periods of time, unplug the power cord from the power outlet.

NOTE

The settings made for the various functions may be cleared if the power cord is left unplugged from a power outlet for an extended period of time.

Setting the current time (Auto Adjust) (24-Hour Display)

When this unit is connected to the network, the current time is automatically set.



- The default time zone of this unit is set to Central European Time. To change the Time Zone and Summer Time, see “Adjusting the clock automatically (Auto Adjust)” ([page 22](#)).
- When this unit is not connected to the network, set the time manually. See “Setting the current time (Manual Adjust) (24-Hour Display)” ([page 23](#)).

Operations possible during playback

Selecting the input source

You can select the device for which this unit outputs the audio that is connected to this unit.

Press .



- The input source is switched each time the button is pressed.



* These items are displayed if a relevant device is connected to this unit.

- When the AirPlay playback starts, the input source on this unit automatically switches to “AirPlay” and playback starts.

Adjusting the master volume

Press + or –.

The volume level is displayed.

[Adjustable range] 0 – 99

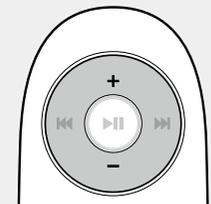

Adjusting the tone (LOUDNESS)

When you press **LOUDNESS** on the main unit to the "On" (🔊) state, bass and treble sounds, which are hard to hear at a low volume level, are enhanced for a more natural audio quality.

Press **LOUDNESS** on the main unit.

"🔊" appears on the display.



- Press the button again to the "Off" (🔇) state to return to the original audio quality.

Last function memory

This function stores the settings (Input source, Volume level and setting value of each menus) which were made before going into the standby mode.

When the power is turned back on, the settings are restored.

Playing an iPhone and iPod with the USB cable connected

With this unit, you can listen to music on an iPhone or iPod. It is also possible to operate the iPhone or iPod from the main unit or remote control.

Connect the iPhone or iPod to this unit (👉 [page 6](#) "Connecting an iPhone or iPod").

When the iPhone or iPod is connected to this unit, the input source automatically switches to "iPod".

- During AirPlay, the input source does not switch automatically. Press 🎵 to switch the input source to "iPod".

NOTE

This function is activated around 30 seconds after the power is turned on.

Remote control and iPhone or iPod button relations

Remote control buttons	iPhone or iPod buttons	Operation on this unit
▶▶	▶ or	Play the track / Pause the track.
⏮, ▶▶ (Press and release)	⏮, ▶▶ (Press and release)	Play the track from the beginning/ Play the next track.
⏮, ▶▶ (Press and hold)	⏮, ▶▶ (Press and hold)	Fast-reverse the track/ Fast-forward the track.

Disconnecting an iPhone or iPod

- 1 Press ⏻ to set the standby mode.
- 2 Disconnect the USB cable from the USB port of this unit.



NOTE

- Depending on the type of iPhone or iPod and the software version, some functions may not operate.
- Note that Denon will accept no responsibility whatsoever for any problems arising with the data on an iPhone or iPod when using this unit in conjunction with the iPhone or iPod.

AirPlay function

You can use this unit to play back music files in your iTunes music libraries, iPhone and iPod touch.

NOTE

- Before using the AirPlay function, this unit must be connected to the network. For how to connect this unit to the network, see "Network connections" (page 8).
- To use the AirPlay function, you must update iPhone or iPod touch to iOS 4.2.1 or higher.
- For iPods that do not support Wi-Fi connection such as the iPod classic and iPod nano, AirPlay playback is not possible. Perform playback according to "Playing an iPhone and iPod with the USB cable connected" (page 12).
- The iPhone or iPod cannot be charged during AirPlay.

Streaming music stored in iPhone or iPod touch directly to the unit

1 Connect your iPhone or iPod touch to the network.

- For details, see your device's manual.

2 Startup iPhone or iPod touch music or iPod app.

 is displayed on the iPhone or iPod touch screen.

3 Tap the AirPlay icon .

4 Tap the speaker (Cocoon Home) you want to play back with.

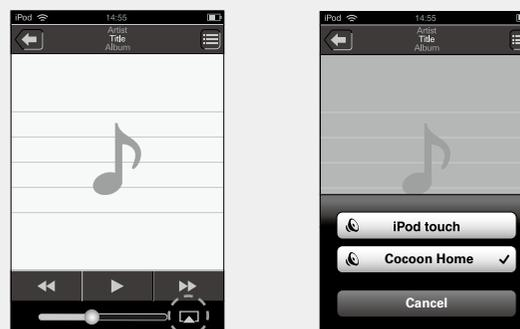

NOTE

When the AirPlay function is used, this unit plays back at the volume level set on iPhone, iPod touch, or iTunes. First minimize the volume level on iPhone, iPod touch, or iTunes before playback. Then, start playback and adjust the volume to the desired level.

Playing iTunes music with this unit

1 Install iTunes 10, or later, on a Mac or Windows PC that is connected to the same network as this unit.

2 Turn this unit ON.

3 Launch iTunes and click the AirPlay icon displayed in the lower right of the window and select this unit from the list.

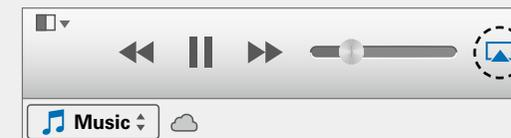

4 Choose a song and click play in iTunes.

The music will stream to this unit.

Selecting multiple speakers (devices)

It is possible to play iTunes songs on your home's AirPlay compatible speakers (devices) other than those of this unit.

1 Click the AirPlay icon and select "Multiple" from the list.

2 Check the speakers you want to use.

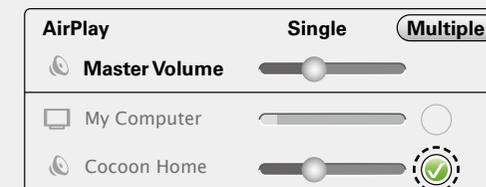

□ Perform iTunes playback operations with the remote control unit of this unit

With this unit's remote control unit, you can perform iTunes song play, pause, and auto search (cue) operations.

1 Select “Edit” – “Preferences...” on the menu.

2 Select “Devices” in the iTunes setting window.

3 Check “Allow iTunes audio control from remote speakers”, and then click “OK”.

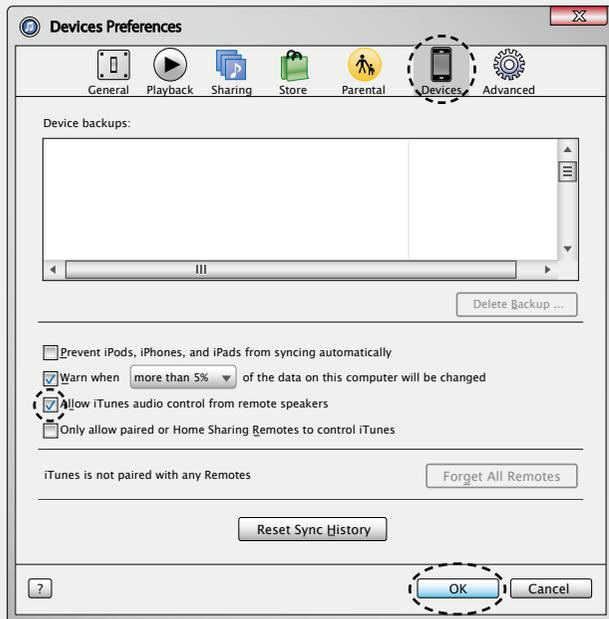

- For details on how to operate the remote control, please refer to “Remote control and iPhone or iPod button relations” ([page 12](#)).
- When the AirPlay playback starts, the input source on this unit automatically switches to “AirPlay” and playback starts.
- You can stop AirPlay playback by choosing another input source.
- For information about how to use iTunes, see also the Help for iTunes.
- The screen may differ depending on the OS and software versions.

Listening to Internet Radio

Internet Radio refers to radio broadcasts distributed over the Internet. Internet Radio stations from around the world can be received.

NOTE

Before playing back Internet Radio, this unit must be connected to the network. For how to connect this unit to the network, see "Network connections" (page 8).

Important information

The broadcast station types and format specifications supported by this unit for playback are as follows.

[Playable broadcast station types]

Supported file types	Internet Radio
WMA (Windows Media Audio)	✓
MP3 (MPEG-1 Audio Layer-3)	✓

[Playable broadcast station specifications]

	Sampling frequency	Bit rate	Extension
WMA (Windows Media Audio)	32/44.1/48 kHz	48 – 192 kbps	.wma
MP3 (MPEG-1 Audio Layer-3)	32/44.1/48 kHz	32 – 320 kbps	.mp3

Listening to preset Internet Radio stations

Typical Internet Radio stations are pre-registered to "Preset 1-3".

1 Prepare for playback.

- ① Check the network environment, then turn on this unit's power (page 11 "Turning the power on").
- ② If settings are required, make the "Network connections" (page 8).

- ### 2 Press to switch the input source to "Preset 1", "Preset 2" or "Preset 3".
- Playback starts.



❑ Customising the Internet Radio station preset channels

This unit has been set Internet Radio stations to "Preset 1 – 3". To customize these channels, use Cocoon App.



- 1 Tap "Internet Radio" on Cocoon App.
- 2 Select an Internet Radio station.
- 3 Register the selected station to the desired preset number.



- There are many Internet Radio stations, and the quality of the programs they broadcast as well as the bit rate of the tracks varies widely. Generally, the higher the bit rate, the higher the sound quality, but depending on the communication lines and server traffic, the music or audio signals being streamed may be interrupted. Inversely, lower bit rates mean a lower sound quality but less tendency for the sound to be interrupted.
- "Server Full" or "Connection Down" is displayed if the station is busy or not broadcasting.
- The Internet Radio station name appears on the display of this unit.

NOTE

The radio station database service may be suspended without notice.

❑ Internet Radio operation buttons

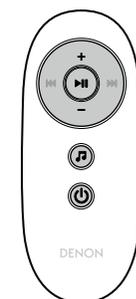

Operation buttons	Function
+ , -	Volume up / down
	Mute On/Off
	Switching the input source
	Power on/standby

Playing a portable player

The following describes the procedure for playing a portable player.

- 1 Connect the portable player to this unit (page 5 "Connecting a portable player").
- 2 Press  to turn on power to the main unit.
- 3 Press  to switch the input source to "AUX".
- 4 Play the component connected to this unit.

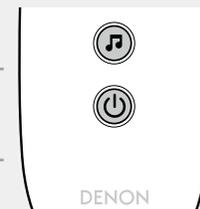

Playing back files stored on a PC or NAS (Network Attached Storage) with the Cocoon App (Music Server)

This unit can play back music files and playlists (m3u, wpl) stored on a PC, Digital Media Server (DMS) and on Network Attached Storage (NAS) that supports DLNA.

NOTE

Before playing back music files on music servers, this unit must be connected to the network. For more about how to connect this unit to the network, see "Connecting to a home network (LAN)" ([page 7](#)).



For playable file formats and restrictions, see "Important information" ([page 18](#)).

Applying media sharing settings

Here, we apply the settings to share music files stored on a PC and NAS on the network.

Sharing media stored in PC

If you are using a media server, be sure to apply this setting first.



- While this unit is operated by a media control device, "Music Server" appears on the display of this unit.
- When selecting this unit from the media control device, the name of this unit is displayed as its friendly name.
- To check the friendly name, see "Checking the network information" ([page 20](#)).

Settings for playing back with Windows Media Player 12 (Windows 7)

NOTE

Perform this procedure after changing the control panel display to "Category".

- 1** In the PC's "Control Panel", select "Network and Internet" – "Choose homegroup and sharing options".
- 2** Select "Stream my pictures, music, and videos to all devices on my home network" check box and select "Choose media streaming options".
- 3** Select "Allowed" in the drop-down list for "Cocoon Home".
- 4** Select "Allowed" in the drop-down list for "Media programs on this PC and remote connections...".
- 5** Click "OK" to finish.

Settings for playing back with Windows Media Player 12 (Windows 8)

NOTE

Perform this procedure after changing the control panel display to "Category".

- 1** In the PC's "Control Panel", select "Network and Internet" – "Choose homegroup and sharing options".
- 2** Select "Allow all devices on this network such as TVs and game consoles to play my shared content".
(The PC needs to be part of a home group.)
- 3** Select "Allowed" in the drop-down list for "Cocoon Home".
- 4** Select "Allowed" in the drop-down list for "Media programs on this PC and remote connections...".
- 5** Click "OK" to finish.

Settings for playing back with Windows Media Player 11

- 1** Start up Windows Media Player 11 on the PC.
- 2** Select “Media Sharing” in the “Library”.
- 3** Click the “Share my media” check box, select “Cocoon Home”, and then click “Allow”.
- 4** As you did in step 3, select the icon of the device (other PCs and mobile devices) you want to use as a media controller, and then click “Allow”.
- 5** Click “OK” to finish.

Sharing media stored on the NAS

Change settings on the NAS to allow this unit and other devices (PCs and mobile devices) used as media controllers to access the NAS. For details, see the owner’s manual that came with the NAS.



About playback

When you start playback on a PC, NAS, or DMS, the input source for this unit automatically switches to “Music Server”, and audio is output from this unit. If the input source does not switch to “Music Server” automatically, switch the input source to “Internet Radio” or “iPod” before playback.

The name of the currently played back track and its artist name appear on the display of this unit.

Use Cocoon App to play back/stop files and perform other operations. You can also adjust or mute the volume.

Pressing while this unit is playing back stops the playback on this unit and switches to “Preset 1”.



- When using a server that supports transcoding such as Windows Media Player (version 11 or higher), you can play back WMA Lossless files.
- Depending on the played back file, the track name or artist name may not be displayed.

NOTE

The music display order depends on the specifications of your PC, NAS, or DMS.

Music Server operation buttons

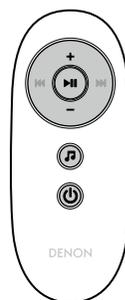

Operation buttons	Function
+ , -	Volume up / down
	Play the track / Pause the track
	Switching the input source
	Power on/standby

Important information

- The network audio playback function of this unit connects to the server using technologies shown below.
 - Windows Media Player Network Sharing Service
- File types that this unit can play back and specifications are shown below.

[Supported file types]

Supported file types	Music Server *1
WMA (Windows Media Audio)	✓*2
MP3 (MPEG-1 Audio Layer-3)	✓
WAV	✓
MPEG-4 AAC	✓*2
FLAC (Free Lossless Audio Codec)	✓

A server or server software compatible with distribution in the corresponding formats is required to play music files via a network.

*1 Music Server

- This unit is compatible with MP3 ID3-Tag (Ver. 2) standard.
- This unit is compatible with WMA META tags.

*2 Only files that are not protected by copyright can be played on this unit.

Content downloaded from pay sites on the Internet may be copyright protected. Also, files encoded in WMA format when ripped from a CD, etc. on a computer may be copyright protected, depending on the computer's settings.

NOTE

File types that this unit does not support are not displayed.

[Specifications of supported files]

	Sampling frequency	Bit rate	Extension
WMA (Windows Media Audio)	32/44.1/48 kHz	48 – 192 kbps	.wma
MP3 (MPEG-1 Audio Layer-3)	32/44.1/48 kHz	32 – 320 kbps	.mp3
WAV	32/44.1/48 kHz	–	.wav
MPEG-4 AAC	32/44.1/48 kHz	16 – 320 kbps	.aac/ .m4a/ .mp4
FLAC (Free Lossless Audio Codec)	32/44.1/48 kHz	–	.flac

How to make detailed settings

Menu map

Setting items	Detailed items	Description	Default	Page
Network Info.		Display network information. Friendly Name (Cocoon Home) / DHCP / IP Address / Primary DNS / Secondary DNS / MAC Address	-	20
Firmware Update		Starts the firmware update procedure. If this unit is updated, the menu settings and preset internet radio stations will be reset to the default settings.	-	20
Max Volume Level		Make a setting for maximum volume.	99	21
Language		Sets the language for display the menu.	English	21
Clock	Auto Adjust(On)	Automatically performs the clock setting from the time information on the Internet.	On	22
	Time Zone(+1H)	Sets your local time zone (for Auto Adjust).	+1H	22
	Summer Time(Off)	Sets the Summer Time information (for Auto Adjust).	Off	22
	Set Time Now	Obtains the current time.	-	23
	Manual Adjust	Adjusts the clock manually. "Manual Adjust" is available when "Auto Adjust(Off)" is set.	-	23
Auto-Standby		With the Auto Standby ON, this unit will automatically enter the standby mode after about 30 continuous minutes of stop mode with no operation.	On	24
Network Control		Set the network function on or off during standby.	Off	24
WPS(PIN)		Sets the wireless connection using WPS (PIN code method). (This setting item is not displayed when using a wired connection.)	-	24
Factory Reset		Reset to the defaults.	-	33
Exit		To exit the menu, select "Exit".	-	-

Menu operation

This section explains the basic menu operations. Steps for item selecting and menu exiting are common to all menus. For detailed operations on each menu, see the respective paragraphs.

NOTE

Use buttons on the remote controller for menu operations. Buttons on this unit are also available.

1 Press and hold  for more than 3 seconds.

Settings

2 Press + or - to select the menu to be set.

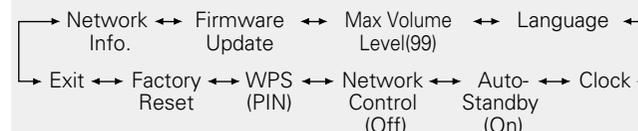

3 Press  to enter the setting.

- To exit the menu, select "Exit" in the top menu, and press . The menu disappears.

❑ Exiting the menu to return to the normal mode

Press  until the input source is displayed.

- The unit exits the setting mode and the normal display returns.



To return to the previous item, use + or - to select "Back" and then press , or press .

Setting up the network (Network Info.)

Checking the network information

- 1 Press and hold  for more than 3 seconds.

Settings

- 2 Press + or – to select “Network Info.”, then press .

Network Info.

- 3 Press + or – to select the item you want to check, then press .

- You can check the following items:
Friendly Name (Cocoon Home) / DHCP/
IP Address / Primary DNS / Secondary DNS / MAC Address

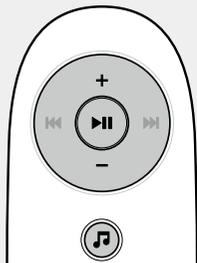

❑ Exiting the menu to return to the normal mode

Press  until the input source is displayed.

- The unit exits the setting mode and the normal display returns.



To return to the previous item, use + or – to select “Back” and then press , or press .

Firmware Update

- This function requires the Internet connection ([page 8](#)).
- When the latest firmware is available, “” is displayed.
- Perform the firmware update operation only after at least 2 minutes has elapsed since turning this unit’s power ON.

NOTE

If this unit is updated, the menu settings and preset internet radio stations will be reset to the default settings.

- 1 Press and hold  for more than 3 seconds.

Settings

- 2 Press + or – to select “Firmware Update”, then press .

Firmware Update

- 3 Press + or – to select “Check for Update”, then press .

Check for Update Check for firmware updates.

Use + or – to select the item, and press .

- No update available: The unit already has the latest firmware.
- Update Now: Updates to the latest firmware.
- Update Later: Updates the latest firmware at a later date.
- If updating fails, the set automatically retries, but if updating is still not possible, one of the messages shown below is displayed. If the display reads as shown below, check the settings and network environment, then update again.

Display	Description
Updating fail	Updating failed.
Login failed	Failure to log into server.
Server is busy	Server is busy. Wait a while then try again.
Connection fail	Failure in connecting to server.
Download fail	Downloading of the firmware has failed.

❑ Exiting the menu to return to the normal mode

Press  until the input source is displayed.

- The unit exits the setting mode and the normal display returns.



To return to the previous item, use + or – to select “Back” and then press , or press .

❑ Notes concerning use of “Firmware Update”

- Do not turn off the power until updating or upgrading is completed.
- Even with a broadband connection to the Internet, approximately 20 minutes is required for the updating procedure to be completed.
- Once updating starts, normal operations on this unit cannot be performed until updating is completed.
- If the update fails, remove and re-insert the power cord. “Update Retry” appears on the display and update restarts from the point at which update failed. If the error continues despite this, check the network environment.



See the Denon website for details about updates.

Setting the volume limit (Max Volume Level)

Make a setting for maximum volume.

- The default setting is "99".

1 Press and hold  for more than 3 seconds.

Settings

2 Press + or - to select "Max Volume Level", then press .

Max Volume Level(99)

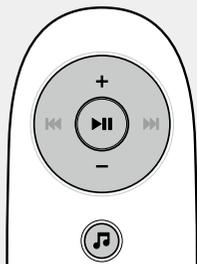

- This unit enters the maximum volume setting mode and the current max volume level is displayed.

3 Press + or - to select the volume "0 - 99", then press .

The "Max Volume Level" menu is displayed again.

❑ Exiting the menu to return to the normal mode

Press  until the input source is displayed.

- The unit exits the setting mode and the normal display returns.

Setting the language (Language)

Sets the language for display the menu.

- The default setting is "English".

1 Press and hold  for more than 3 seconds.

Settings

2 Press .

The unit enters the setting mode of the language menu, and shows the language currently selected.



3 Press + or - to select the language you want to set.

English ↔ Deutsch ↔ Français ↔ Español ↔ Italiano
Back ↔ РУССКИЙ ↔ Nederlands ↔ Svenska

4 Press .

The setting is entered, and the "Language" menu is displayed again.

❑ Exiting the menu to return to the normal mode

Press  until the input source is displayed.

- The unit exits the setting mode and the normal display returns.



To return to the previous item, use + or - to select "Back" and then press , or press .

Setting the clock (Clock)

You can automatically adjust the clock of this unit using the Internet.



To use this function, the unit must be connected to the Internet.

Adjusting the clock automatically (Auto Adjust)

This function automatically adjusts the clock at power on or other times.

- 1 Press and hold for more than 3 seconds.

Settings

- 2 Press + or - to select "Clock", then press .

Clock

- 3 Press + or - to select "Auto Adjust(On)", then press .

Auto Adjust(On)

- 4 Press + or - to select "Auto-Adjust On" or "Auto-Adjust Off", then press .

Auto-Adjust On Automatically adjusts the clock.
The operation to receive the current time starts.

Auto-Adjust Off Does not automatically adjust the clock.

- If you press , the setting is entered and "Auto Adjust" menu is displayed again.

Exiting the menu to return to the normal mode

Press until the input source is displayed.

- The unit exits the setting mode and the normal display returns.

Setting the Time Zone (Time Zone)

Use the following procedure to select your local standard time (time zone).

- 1 Press and hold for more than 3 seconds.

Settings

- 2 Press + or - to select "Clock", then press .

Clock

- 3 Press + or - to select "Time Zone(+1H)", then press .

Time Zone(+1H)

- 4 Press + or - to select your local standard time (time zone) in your lives, then press .
- The "Time Zone" menu is displayed again.

Exiting the menu to return to the normal mode

Press until the input source is displayed.

- The unit exits the setting mode and the normal display returns.

Setting the Summer Time (Summer Time)

Use the following procedure to set Summer time if the Summer time system is used in your country.

- 1 Press and hold for more than 3 seconds.

Settings

- 2 Press + or - to select "Clock", then press .

Clock

- 3 Press + or - to select "Summer Time(Off)", then press .

Summer Time(Off)

- 4 Press + or - to select "Summer Time Off" or "Summer Time On", then press .
- The "Summer Time" menu is displayed again.

Exiting the menu to return to the normal mode

Press until the input source is displayed.

- The unit exits the setting mode and the normal display returns.

Setting the current time (Set Time Now)

When the unit is connected to the Internet, the current time is set automatically.

- 1 Press and hold  for more than 3 seconds.

Settings

- 2 Press + or - to select “Clock”, then press .

Clock



- 3 Press + or - to select “Set Time Now”, then press .

The operation to receive the current time starts.

Set Time Now

- The current time is displayed for several seconds when it is received successfully.
- If the current time is not received successfully, “Connection Failed” appears.

Exiting the menu to return to the normal mode

Press  until the input source is displayed.

- The unit exits the setting mode and the normal display returns.

Setting the current time (Manual Adjust) (24-Hour Display)

You can set the current time manually.

- “Manual Adjust” is available when “Auto Adjust(Off)” ([page 22](#)) is set.

- 1 Press and hold  for more than 3 seconds.

Settings

- 2 Press + or - to select “Clock”, then press .

Clock



- 3 Press + or - to select “Manual Adjust”, then press .

Manual Adjust

- 4 Press + or - to set the “hours”, then press .

- 5 Press + or - to set the “minutes”, then press .
- The current time is set.

Exiting the menu to return to the normal mode

Press  until the input source is displayed.

- The unit exits the setting mode and the normal display returns.

Auto-Standby

With the Auto Standby set to ON, this unit will automatically enter the standby mode after about 30 continuous minutes of stop mode with no operation.

- The default setting is "On".

- 1 Press and hold  for more than 3 seconds.

Settings

- 2 Press + or - to select "Auto-Standby", then press .

Auto-Standby(On)

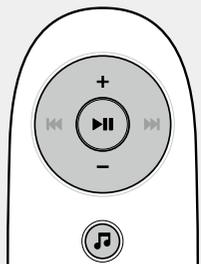

Auto-Satandby Off The unit does not go into standby automatically.

Auto-Satandby On The unit goes into standby after 30 minutes.

NOTE

In the following situations, the Auto standby function does not operate.

- When the input source is "AUX" and a device connected to the AUX IN jack.
- When the input source being played is "Internet Radio" or "Music Server".

❑ Exiting the menu to return to the normal mode

Press  until the input source is displayed.

- The unit exits the setting mode and the normal display returns.



To return to the previous item, use + or - to select "Back" and then press , or press .

Network Control

Set the network function on or off during standby.

- The default setting is "Off".

- 1 Press and hold  for more than 3 seconds.

Settings

- 2 Press + or - to select "Network Control", then press .

Network Control(Off)



Network Always On Network is on during standby. Main unit is operable with a network compatible controller.

Network Off in Standby Suspends the network function during standby.

NOTE

When "Network Control" is set to "Network Always On", it consumes more standby power.

❑ Exiting the menu to return to the normal mode

Press  until the input source is displayed.

- The unit exits the setting mode and the normal display returns.



To return to the previous item, use + or - to select "Back" and then press , or press .

Wi-Fi Protected Setup (WPS) Settings (PIN code method)

Sets the wireless connection using WPS (PIN code method).



This setting item is not displayed when using a wired connection. Before turning this unit on, make sure that a LAN cable is not connected to this unit.

When a LAN cable is connected, set the power to standby and disconnect the LAN cable.

- 1 Press and hold  for more than 3 seconds.

Settings

- 2 Press + or - to select "WPS(PIN)", then press .

WPS(PIN)

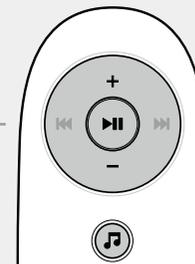

- "Searching" is displayed, and the access point you have set is displayed.

- 3 Press + or - to select the access point whose PIN code you want to display, and press .

The PIN code number is displayed.

- 4 Set this PIN code to the register.

- For how to register the PIN code, see the owner's manual of your router with access point.
- When connection is established with access point, "Connected!" is displayed.

❑ Exiting the menu to return to the normal mode

Press  until the input source is displayed.

- The unit exits the setting mode and the normal display returns.



To return to the previous item, use + or - to select "Back" and then press , or press .

Information

Here, we list various information related to this unit.
Please refer to this information as needed.

- Part names and functions  [page 26](#)
- Other information  [page 28](#)
- Troubleshooting  [page 31](#)
- Specifications  [page 33](#)
- Index  [page 34](#)

Part names and functions

Front panel

For buttons not explained here, see the page indicated in parentheses ().

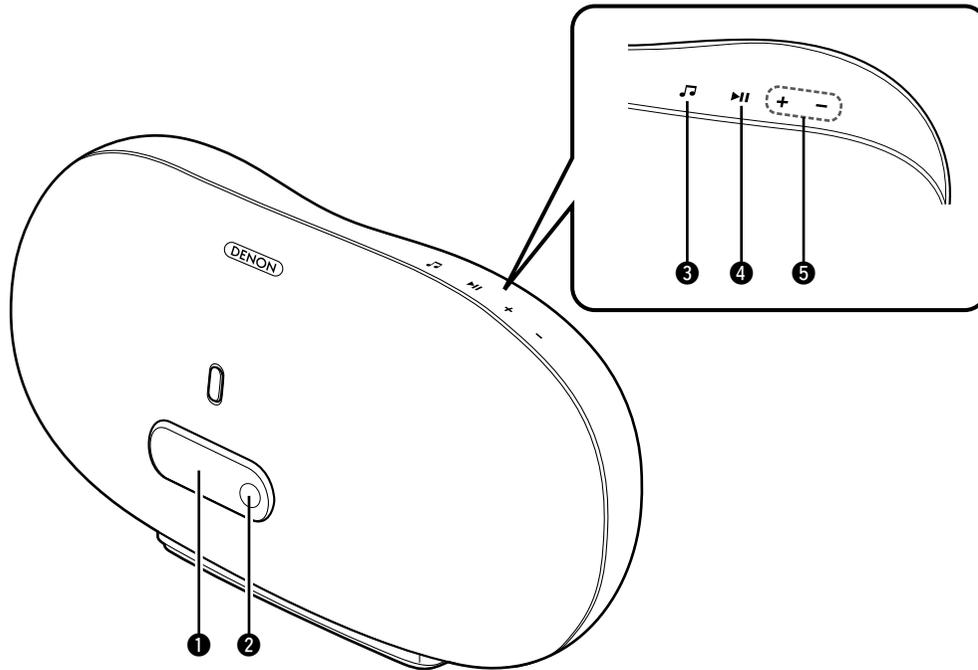

- 1 Display**
 [Wireless LAN signal strength]
- : Strong
 - : Medium
 - : Weak
 - : Not connected
- [Other indications]
- : Loudness (12)
 - : Update notification (20)

- 2 Remote control sensor** (3)
- 3 Input source select button (🎵)** (11)
- Menu button (🎵)** (19)
- 4 Play/Pause button (▶||)** (12, 19, 33)
- 5 Volume control buttons (+, -)** (11, 19, 33)

Rear panel

See the page indicated in parentheses ().

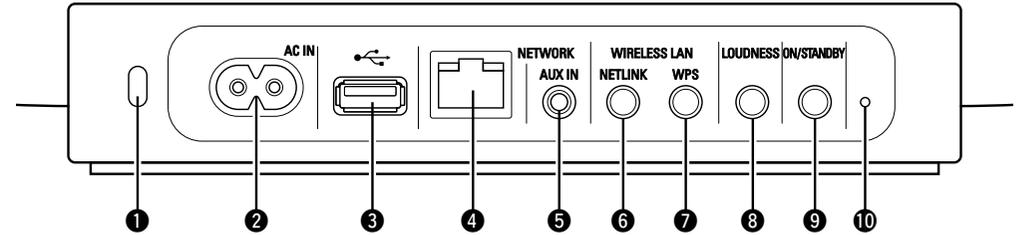

- 1 Security slot**
 You can attach a security cable to deter theft. Use a security cable that is compatible with this unit. For details, contact your dealer.
- NOTE**
 Security cables have deterrent effects, but they do not completely prevent theft or misuse of this unit.
- 2 AC inlet (AC IN)** (5)
- 3 USB port** (6)
- 4 Network connector (NETWORK)** (8)
- 5 AUX IN jack** (5)
- 6 NETLINK button** (Quick Setup Guide)
- 7 WPS button** (Quick Setup Guide)
- 8 LOUDNESS button** (12)
- 9 Power operation button (ON/STANDBY)** (11)
 Turns power to this unit on and off (standby).
- 10 Reset access hole** (33)

Remote control unit

For buttons not explained here, see the page indicated in parentheses ().

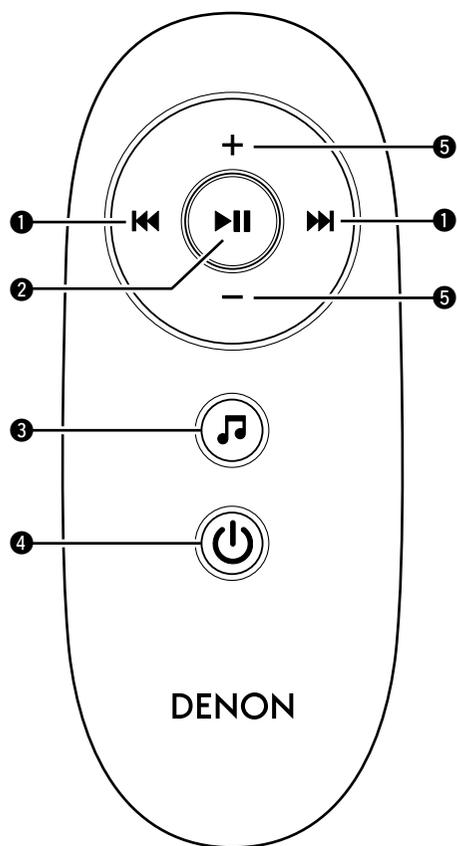

- ❶ Skip buttons (⏮, ⏭) (12)
- ❷ Play/Pause button (▶⏸) (12, 19, 33)
- ❸ Input source select button (🎵) (11)
Menu button (🎵) (19)
- ❹ Power operation button (⏻) (11)
- ❺ Volume control buttons
(+, -) (11, 19, 33)

Other information

❑ **Trademark information** ([page 28](#))

❑ **Explanation of terms** ([page 29](#))

Trademark information



“Made for iPod” and “Made for iPhone” mean that an electronic accessory has been designed to connect specifically to iPod, or iPhone, respectively, and has been certified by the developer to meet Apple performance standards.

Apple is not responsible for the operation of this device or its compliance with safety and regulatory standards. Please note that the use of this accessory with iPod, or iPhone, may affect wireless performance.

AirPlay, the AirPlay logo, iPad, iPhone, iPod, iPod classic, iPod nano, iPod shuffle and iPod touch are trademarks of Apple Inc., registered in the U.S. and other countries.

- Individual users are permitted to use iPhone, iPod, iPod classic, iPod nano, iPod shuffle, and iPod touch for private copy and playback of non-copyrighted contents and contents whose copy and playback is permitted by law. Copyright infringement is prohibited by law.



Adobe, the Adobe logo and Reader are either registered trademarks or trademarks of Adobe Systems Incorporated in the United States and/or other countries.

Explanation of terms

A

AES (Advanced Encryption Standard)

This is a next generation standard encryption method replacing the current DES and 3DES, and because of its high security it is expected to be applied widely to wireless LANs in the future. It uses the "Rijndael" algorithm developed by two Belgian cryptographers to divide the data into blocks of fixed lengths and encrypt each block. It supports data lengths of 128, 192 and 256 bits and key lengths of 128, 192 and 256 bits as well, offering extremely high encryption security.

AirPlay

AirPlay sends (plays) contents recorded in iTunes or on an iPhone/iPod touch to a compatible device via the network.

App Store

App Store is a site that sells application software for such devices as the iPhone/iPod touch, and is operated by Apple Inc.

B

Bit rate

This expresses the read amount per 1 second of video/audio data recorded on a disc. A larger number means higher sound quality, but also means a larger file size.

D

DLNA

DLNA and DLNA CERTIFIED are trademarks and/or service marks of Digital Living Network Alliance. Some contents may not be compatible with other DLNA CERTIFIED™ products.

F

FLAC

FLAC stands for Free lossless Audio Codec, and is a lossless free audio file format. Lossless means that the audio is compressed without any loss in quality. The FLAC license is as shown below.

Copyright (C) 2000,2001,2002,2003,2004,2005,2006,2007,2008,2009 Josh Coalson

Redistribution and use in source and binary forms, with or without modification, are permitted provided that the following conditions are met:

- Redistributions of source code must retain the above copyright notice, this list of conditions and the following disclaimer.
- Redistributions in binary form must reproduce the above copyright notice, this list of conditions and the following disclaimer in the documentation and/or other materials provided with the distribution.
- Neither the name of the Xiph.org Foundation nor the names of its contributors may be used to endorse or promote products derived from this software without specific prior written permission.

THIS SOFTWARE IS PROVIDED BY THE COPYRIGHT HOLDERS AND CONTRIBUTORS "AS IS" AND ANY EXPRESS OR IMPLIED WARRANTIES, INCLUDING, BUT NOT LIMITED TO, THE IMPLIED WARRANTIES OF MERCHANTABILITY AND FITNESS FOR A PARTICULAR PURPOSE ARE DISCLAIMED. IN NO EVENT SHALL THE FOUNDATION OR CONTRIBUTORS BE LIABLE FOR ANY DIRECT, INDIRECT, INCIDENTAL, SPECIAL, EXEMPLARY, OR CONSEQUENTIAL DAMAGES (INCLUDING, BUT NOT LIMITED TO, PROCUREMENT OF SUBSTITUTE GOODS OR SERVICES; LOSS OF USE, DATA, OR PROFITS; OR BUSINESS INTERRUPTION) HOWEVER CAUSED AND ON ANY THEORY OF LIABILITY, WHETHER IN CONTRACT, STRICT LIABILITY, OR TORT (INCLUDING NEGLIGENCE OR OTHERWISE) ARISING IN ANY WAY OUT OF THE USE OF THIS SOFTWARE, EVEN IF ADVISED OF THE POSSIBILITY OF SUCH DAMAGE.

I

IEEE 802.11b

This is one wireless LAN standard set by the 802 working group that establishes LAN technology standards at the IEEE (Institute of Electrical and Electronics Engineers) of the United States. It uses the 2.4 GHz band usable freely without a radio frequency license (ISM band), enabling communications at a maximum speed of 11 Mbps.

- The value indicated above is the maximum theoretical value for the wireless LAN standard, and does not indicate the actual data transfer rate.

IEEE 802.11g

This is another wireless LAN standard set by the 802 working group that establishes LAN technology standards at the IEEE (Institute of Electrical and Electronics Engineers) of the United States, and is compatible with IEEE 802.11b. It also uses the 2.4 GHz band, but enables communications at a maximum speed of 54 Mbps.

- The value indicated above is the maximum theoretical value for the wireless LAN standard, and does not indicate the actual data transfer rate.

iTunes

iTunes is the name of the multimedia player provided by Apple Inc. It enables management and playback of multimedia contents including music and movies. iTunes supports many main file formats including AAC, WAV, and MP3.

M

MP3 (MPEG Audio Layer-3)

This is an internationally standardized audio data compression scheme, using the "MPEG-1" video compression standard. It compresses the data volume to about one eleventh its original size while maintaining sound quality roughly equivalent to a music CD.

MPEG (Moving Picture Experts Group), MPEG-2, MPEG-4

These are the names for digital compression format standards used for the encoding of video and audio. Video standards include "MPEG-1 Video", "MPEG-2 Video", "MPEG-4 Visual", "MPEG-4 AVC". Audio standards include "MPEG-1 Audio", "MPEG-2 Audio", "MPEG-4 AAC".

N

Network Names (SSID: Security Set Identifier)

When forming wireless LAN networks, groups are formed to prevent interference, data theft, etc. This grouping is done by "SSID" or "Security Set Identifiers". For further security, a WEP key is set and signal transfer is not possible unless the SSID and WEP key match.

P

Protection circuit

This is a function to prevent damage to devices within the power supply when an abnormality such as an overload, excess voltage occurs or temperature for any reason.

In this unit, the power indicator blinks and the unit enters standby mode when an abnormality occurs.

S

Sampling frequency

Sampling involves taking a reading of a sound wave (analog signal) at regular intervals and expressing the height of the wave at each reading in digitized format (producing a digital signal).

The number of readings taken in one second is called the "sampling frequency". The larger the value, the closer the reproduced sound is to the original.

T

TKIP (Temporal Key Integrity Protocol)

This is a network key used for WPA. The encryption algorithm is RC4, the same as for WEP, but the security level is increased by changing the network key used for encryption for each packet.

V

vTuner

This is a free online content server for Internet radio. Note that usage fees are included in upgrade costs.

For inquiries about this service, visit the vTuner site below.

vTuner website: <http://www.radiodenon.com>

This product is protected by certain intellectual property rights of Nothing Else Matters Software and BridgeCo. Use or distribution of such technology outside of this product is prohibited without a license from Nothing Else Matters Software and BridgeCo or an authorized subsidiary.

W

WEP Key (Network Key)

This is key information used for encrypting data when conducting data transfer. On this unit, the same WEP key is used for data encryption and decryption, so the same WEP key must be set on both devices in order for communications to be established between them.

Wi-Fi®

Wi-Fi Certification assures tested and proven interoperability by the Wi-Fi Alliance, a group certifying interoperability among wireless LAN devices.

Windows Media Player Ver.11 or later

This is a media player distributed free of charge by Microsoft Corporation.

It can play playlists created with Ver.11 or later of Windows Media Player, as well as WMA, DRM WMA, WAV, and other files.

WMA (Windows Media Audio)

This is audio compression technology developed by Microsoft Corporation.

WMA data can be encoded using Windows Media® Player Ver.7, 7.1, Windows Media® Player for Windows® XP and Windows Media® Player 9 Series.

To encode WMA files, only use applications authorized by Microsoft Corporation. If you use an unauthorized application, the file may not work properly.

WPA (Wi-Fi Protected Access)

This is a security standard established by the Wi-Fi Alliance. In addition to the conventional SSID (network name) and WEP key (network key), it also uses a user identification function and encrypting protocol for stronger security.

WPA2 (Wi-Fi Protected Access 2)

This is a new version of the WPA established by the Wi-Fi Alliance, compatible with more secure AES encryption.

WPA-PSK/WPA2-PSK (Pre-shared Key)

This is a simple authentication system for mutual authentication when a preset character string matches on the wireless LAN access point and client.

WPS (Wi-Fi Protected Setup)

This is a standard drawn up by the Wi-Fi Alliance to ease the task of setting up wireless LAN connections and configuring security.

There are two methods: push-button and PIN (Personal Identification Number) code.

Troubleshooting

If a problem should arise, first check the following:

1. Are the connections correct?

2. Is the set being operated as described in the owner's manual?

3. Are the other devices operating properly?

If this unit does not operate properly, check the items listed in the table below. Should the problem persist, there may be a malfunction.

In this case, disconnect the power immediately and contact your store of purchase.

[General]

Symptom	Cause/Solution	Page
Power does not turn on.	<ul style="list-style-type: none"> Check whether the power plug is correctly inserted into the power outlet. 	5
The operation buttons on the upper part of this unit flash white approximately every 2 seconds.	<ul style="list-style-type: none"> The protection circuit has been activated by a rise of the temperature inside the unit. Please turn the power off once, and re-apply the power after the temperature has fallen sufficiently. Please re-install this unit in a place having good ventilation. 	29 -
The operation buttons on the upper part of this unit flash white approximately every 0.5 seconds.	<ul style="list-style-type: none"> This unit's amplifier circuit has failed. Turn off the power and please contact a Denon service adviser. 	-
Set does not operate properly.	<ul style="list-style-type: none"> Reset the microprocessor. 	33

[Audio]

Symptom	Cause/Solution	Page
Audio is not output.	<ul style="list-style-type: none"> Check the connections for all devices. Check whether the audio device power is turned on. Adjust the master volume. Check the connection with the playback device and select the proper input source. 	5 , 6 , 8 - 11 11

[iPod / Internet Radio / Music Server]

Symptom	Cause/Solution	Page
iPhone or iPod cannot be played.	<ul style="list-style-type: none"> Some iPhone or iPod do not support being connected directly to the USB port. 	6
The file names are not displayed properly ("...", etc.).	<ul style="list-style-type: none"> Characters that cannot be displayed are used. This is not a malfunction. On this unit, characters that cannot be displayed are replaced with a "." (period). 	-
Internet Radio cannot be played.	<ul style="list-style-type: none"> LAN cable is not properly connected or network is disconnected. Check the connection status. Program is being broadcast in a non-compatible format. Only Internet Radio programs in MP3 and WMA can be played on this unit. The firewall of the PC or router has been activated. Check the firewall settings of the connected PC or router. Radio station is not currently broadcasting. Choose a radio station that is currently broadcasting. IP address is wrong. Check the set's IP address. Some radio stations may go silent at certain times of the day. In this case, no audio is output even when a station is received. Try again later, or switch to another radio station. 	8 15 - - 20 -
Files stored on a computer cannot be played.	<ul style="list-style-type: none"> Files are stored in a non-compatible format. Record in a compatible format. You are attempting to play a file that is copyright protected. Files that are copyright protected cannot be played on this unit. Set and computer are connected by USB cable. The set's USB port cannot be used for connection to a computer. Media sharing settings are not correct. Change media sharing settings so that the unit can access the folders on your computer. 	18 18 - 16
Music stored on a NAS cannot be played.	<ul style="list-style-type: none"> If you use a NAS in conformity with the DLNA standard, enable the DLNA server function in the NAS setting. If you use a NAS that does not conform with the DLNA standard, play the music via a PC. Set Windows Media Player's media sharing function and add NAS to the selected play folder. If connection is restricted, set audio equipment as the connection target. 	- 16 -

Symptom	Cause/Solution	Page
Files on a USB memory device cannot be played.	<ul style="list-style-type: none"> This unit does not support playback of files from a USB memory device. 	–
Server is not found, or it is not possible to connect to the server.	<ul style="list-style-type: none"> The computer's or router's firewall is activated. Check the computer's or router's firewall settings. Computer's power is not turned on. Turn on the power. Server is not running. Launch the server. Set's IP address is wrong. Check the set's IP address. 	– – – 20
Cannot connect to preset radio stations.	<ul style="list-style-type: none"> Radio station is not currently broadcasting. Wait a while before trying again. Radio station is not currently in service. It is not possible to connect to radio stations that are no longer in service. 	– –
You want to change the registered radio station contents.	<ul style="list-style-type: none"> Use the Cocoon App to select the desired radio station and select the preset number on the playback screen. 	15
For some radio stations, "Radio station server full" or "Connection down" is displayed and station cannot be connected to.	<ul style="list-style-type: none"> Station is congested or not currently broadcasting. Wait a while before trying again. 	–
Sound is broken during playback.	<ul style="list-style-type: none"> Network device's signal transfer speed is slow or communications lines or radio station is congested. This is not a malfunction. When playing broadcast data with a high bit rate, the sound may be broken, depending on the communications conditions. 	–

Symptom	Cause/Solution	Page
Sound quality is poor or noise is heard during play.	<ul style="list-style-type: none"> File being played has a low bit rate. This is not a malfunction. 	–

[AirPlay]

Symptom	Cause/Solution	Page
The AirPlay icon  is not displayed in iTunes or on the iPhone/iPod touch.	<ul style="list-style-type: none"> This unit and the computer or iPhone/iPod touch are not connected to the same network (LAN). Connect the computer or iPhone/iPod touch to the same network as this unit. iTunes or the iPhone/iPod touch do not have firmware that supports AirPlay installed. Update to the latest firmware. 	8 20
No sound.	<ul style="list-style-type: none"> The volume in iTunes or on the iPhone/iPod touch is set to the minimum setting. Adjust the volume to the optimum level. This unit is not selected in the screen that is displayed when iTunes or the iPhone/iPod touch is started. Start iTunes or switch on the iPhone/iPod touch, click the AirPlay icon  in the displayed screen, and select this unit. AirPlay playback has not started. Click the  button in iTunes or press the  button on the iPhone/iPod touch. 	– 13 –
When using AirPlay with the iPhone/iPod touch, the sound suffers from intermittent breaks or AirPlay does not function.	<ul style="list-style-type: none"> Quit the application running in the background of the iPhone/iPod touch, and then play using AirPlay. When playing via a wireless connection, outside conditions may affect the unit. To remedy this, change the network environment, e.g. shorten the distance to the wireless LAN access point. Update the iPhone/iPod touch application or iTunes to the latest version. 	– – –
Cannot recharge the iPod or iPhone.	<ul style="list-style-type: none"> The iPhone or iPod cannot be charged during AirPlay. 	6 , 13

[Remote control unit]

Symptom	Cause/Solution	Page
The set cannot be operated with the remote control unit.	<ul style="list-style-type: none"> Batteries are worn out. Replace with new batteries. Operate the remote control unit within a distance of about 7 m from this unit and at an angle of within 30°. Remove any obstacle between this unit and the remote control unit. Insert the batteries in the proper direction, checking the ⊕ and ⊖ marks. The set's remote control sensor is exposed to strong light (direct sunlight, inverter type fluorescent bulb light, etc.). Move the set to a place in which the remote control sensor will not be exposed to strong light. 	3 3 3 3 3

Resetting the microprocessor (Factory Reset)

When the microprocessor is reset, all the settings are reset to their default values.

1 Press and hold  for more than 3 seconds.

Settings

2 Press + or – to select “Factory Reset”, then press .

Factory Reset

3 Press + or – to select “Reset Factory Defaults”, then press . “Resetting...” is displayed and the default settings are restored.



If “Resetting...” does not display in step 3, start over from step 1.

❑ Exiting the menu to return to the normal mode

Press  until the input source is displayed.

- The unit exits the setting mode and the normal display returns.

How to reset

“Reset” is an operation that restarts this unit. Perform the reset in cases such as when the display does not function properly or you are unable to operate this unit. The existing settings will remain intact.

When the power of this unit is on, insert a thin stick or a needle (*2) into the reset hole (*1), and press the reset button within this unit.

This unit automatically restarts.

- Prepare a thin stick or a needle (such as a toothpick or a straightened paper clip) for pressing the reset button within this unit.

* 1 Thickness (dia.): 0.5 mm – 1.5 mm

* 2 Length: 30 mm or longer

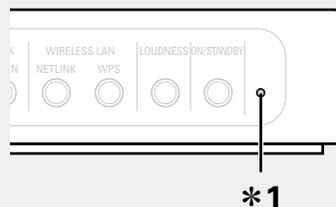

Specifications

❑ Audio section

- **Amplifiers:** 4 x 25 W ClassD
- **Speakers:** 4 cm Tweeter x 2
10 cm Woofer x 2

❑ Wireless LAN

Network type (wireless LAN standards): Conforming to IEEE 802.11b
Conforming to IEEE 802.11g (Conforming to Wi-Fi®)*
Transfer rate: DS-SS: 11 / 5.5 / 1 Mbps (Automatic switching)
OFDM: 54 / 48 / 36 / 24 / 18 / 12 / 9 / 6 Mbps (Automatic switching)

Security: SSID (Network name)
WEP key (network key) (64/128 bits)
WPA-PSK (TKIP/AES)
WPA2-PSK (TKIP/AES)
Used frequency range: 2412 MHz – 2472 MHz
No. of channels: Conforming to IEEE 802.11b : 13ch (DS-SS) (Of which 1 channel is used)
Conforming to IEEE 802.11g : 13ch (OFDM) (Of which 1 channel is used)

❑ General

Power supply: AC 100 – 240 V, 50/60 Hz
Power consumption: 50 W
Power consumption in standby mode: 0.5 W
Power consumption in “Network Control” – “On” mode: 5.5W

- * Wi-Fi® conformity indicates tested and proven interoperability by the “Wi-Fi Alliance”, a group certifying interoperability among wireless LAN devices.

For purposes of improvement, specifications and design are subject to change without notice.

Index

A

Accessories	1
Adjusting the master volume	11
Adjusting the tone	12
AES	29
AirPlay	13, 29
App Store	3, 13, 29
Auto-Standby	24

B

Bit rate	29
----------	----

C

Cable	
LAN cable	8
Power cord	5
Stereo mini plug cable	5
Clock	
Auto Adjust	22
Manual Adjust	23
Set Time Now	23
Summer Time	22
Time Zone	22
Cocoon App	3, 15, 16
Condensation	2
Connection	
Home network (LAN)	7
iPhone/iPod	6
Portable player	5
Power cord	5
Wired LAN	8
Wireless LAN	8

D

Display	26
DLNA	16, 29

F

Factory Reset	33
Firmware Update	20
FLAC	18, 29
Front Panel	26

H

How to reset	33
--------------	----

I

IEEE 802.11b	29
IEEE 802.11g	29
iTunes	13, 29

L

Language	21
----------	----

M

Max Volume Level	21
Menu map	19
Menu operation	19
MP3	15, 18, 29
MPEG	18, 29

N

Network Control	24
Network Info.	20
Network Names	29

O

Operation Mode	12
----------------	----

P

PIN code method	24
Playback	
AirPlay function	13
FLAC	18
Internet Radio	15
iPhone/iPod	12
MP3	15, 18
MPEG-4 AAC	18
Music server	16
NAS	16
PC	16
Portable player	15
WAV	18
WMA	15, 18
Protection circuit	29

R

Rear panel	26
Remote control unit	27
Inserting the batteries	3
Resetting the microprocessor	33

S

Sampling frequency	15, 18, 29
Security slot	26
Selecting the input source	11
Setting the current time	11
Supported iPod models	6

T

TKIP	29
Trademark information	28
Troubleshooting	31
Turning the power on	11

V

vTuner	30
--------	----

W

WAV	18
WEP Key	30
Wi-Fi	30
Windows Media Player	16, 30
WMA	15, 18, 30
WPA	30
WPA2	30
WPA-PSK/WPA2-PSK	30
WPS	30

Dimensions

Unit : mm

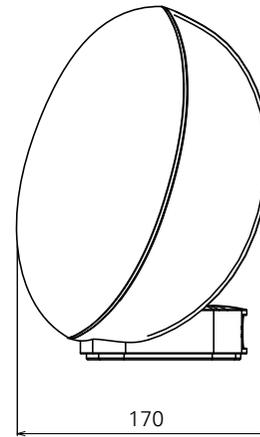
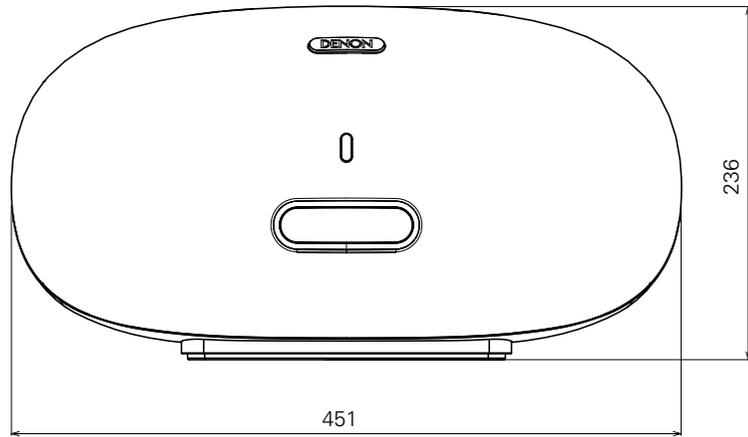

Weight : 5.4 kg

DENON
www.denon.com

D&M Holdings Inc.
3520 10281 00AD